

WATER CONDITIONING SYSTEM

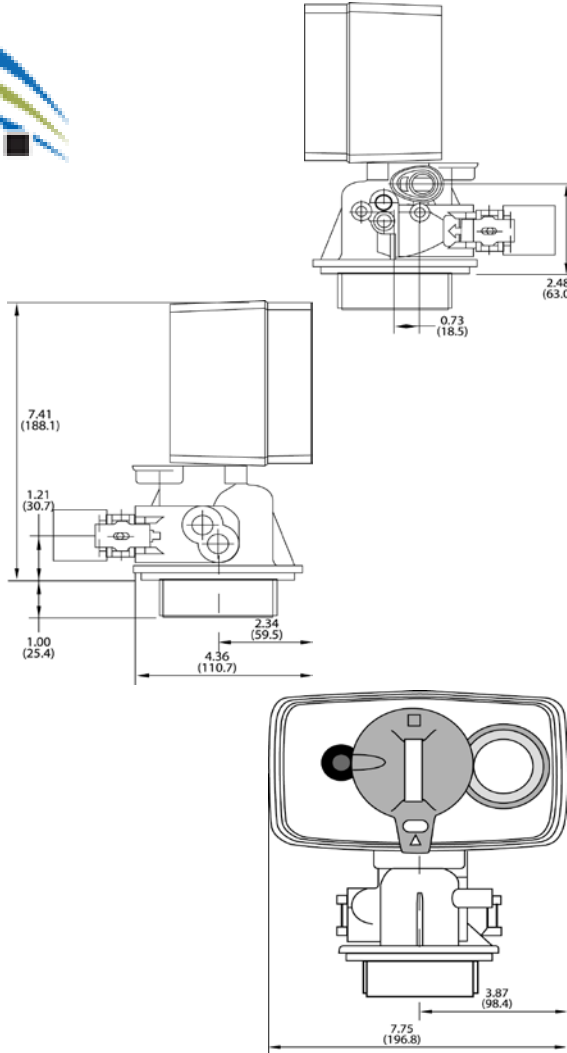
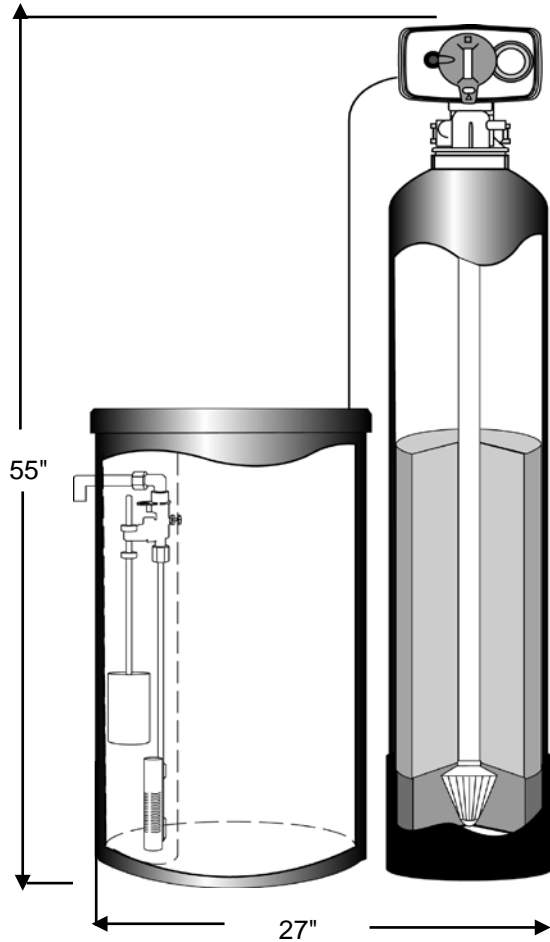

Water Softener Specification

Model #:	WB560S-32
Capacity:	32,000 grains
Flow Rate:	
Peak Flow:	
BW Rate:	2.0 gpm
Tank Size:	9" X 48" Fiberglass
Brine Tank:	18" DIA. X 30" Poly
Media Vol.:	1 cuft
Pipe Size:	
Inlet:	3/4 or 1"
Outlet:	3/4 or 1"
Drain:	1/2"
Weight:	
Shipping:	
Operating:	

Note:

Supply sufficient pipe support to insure that no pipe weight is supported by the softener control.

All Dashed pipe, valves and fittings provided by others.

Make all plumbing connections in accordance with all state and local plumbing codes.

Install sample valve on softener outlet for ease of sampling water hardness.